

Post 11.5 X2

M3 X14 Cap screw X1

3 X6 X0.5 Spacer X4

M3 X30 Screw X2

M3 X20 Screw X3

RMX to RRX Conversion kit
PICKED

RRX Connector X1

Rear spacer X1

U-bush X1

STEP 1 Attaching RRX drive system



STEP 2 Attaching damper stay set

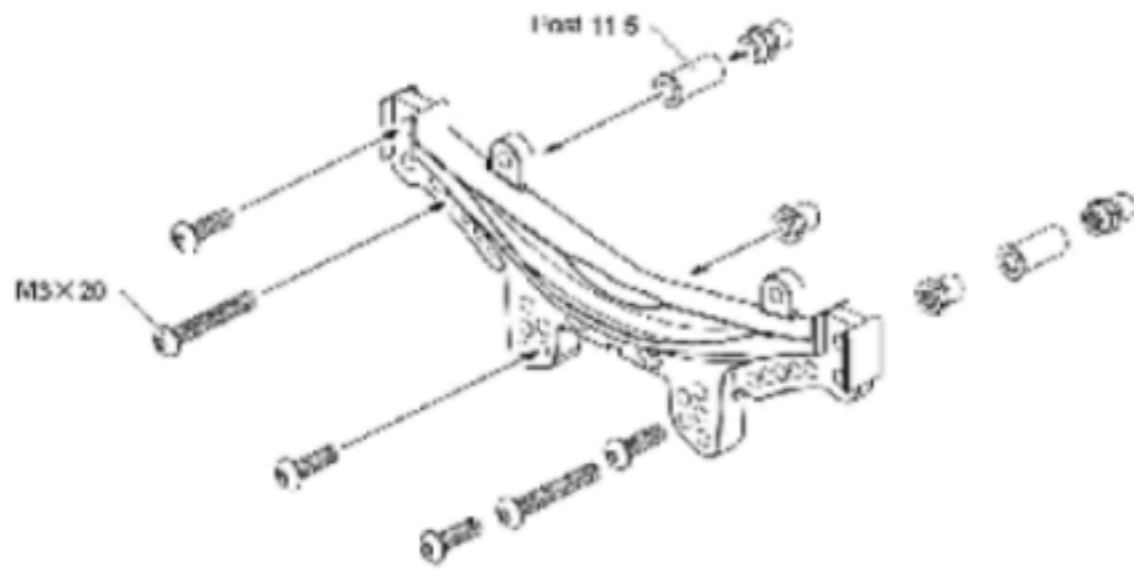

STEP 3 Attaching drive system

